



Labour Force Survey

User Guide

VOLUME 4a – Updates to the LFS Education Derived Variables 2022

Contents

EHATLEV22	1
EHATYR22	3
FLED22	4
FLEX22W1 to 9	5
GCSEFUL1 to 6	10
HIQUAL22	16
HIQUL22D	24
LEVQUL22	25
QUAL21_1 to 39	26
A note on the lower counts for JM22	30

EHATLEV22 – Educational Attainment level (ISCED11)

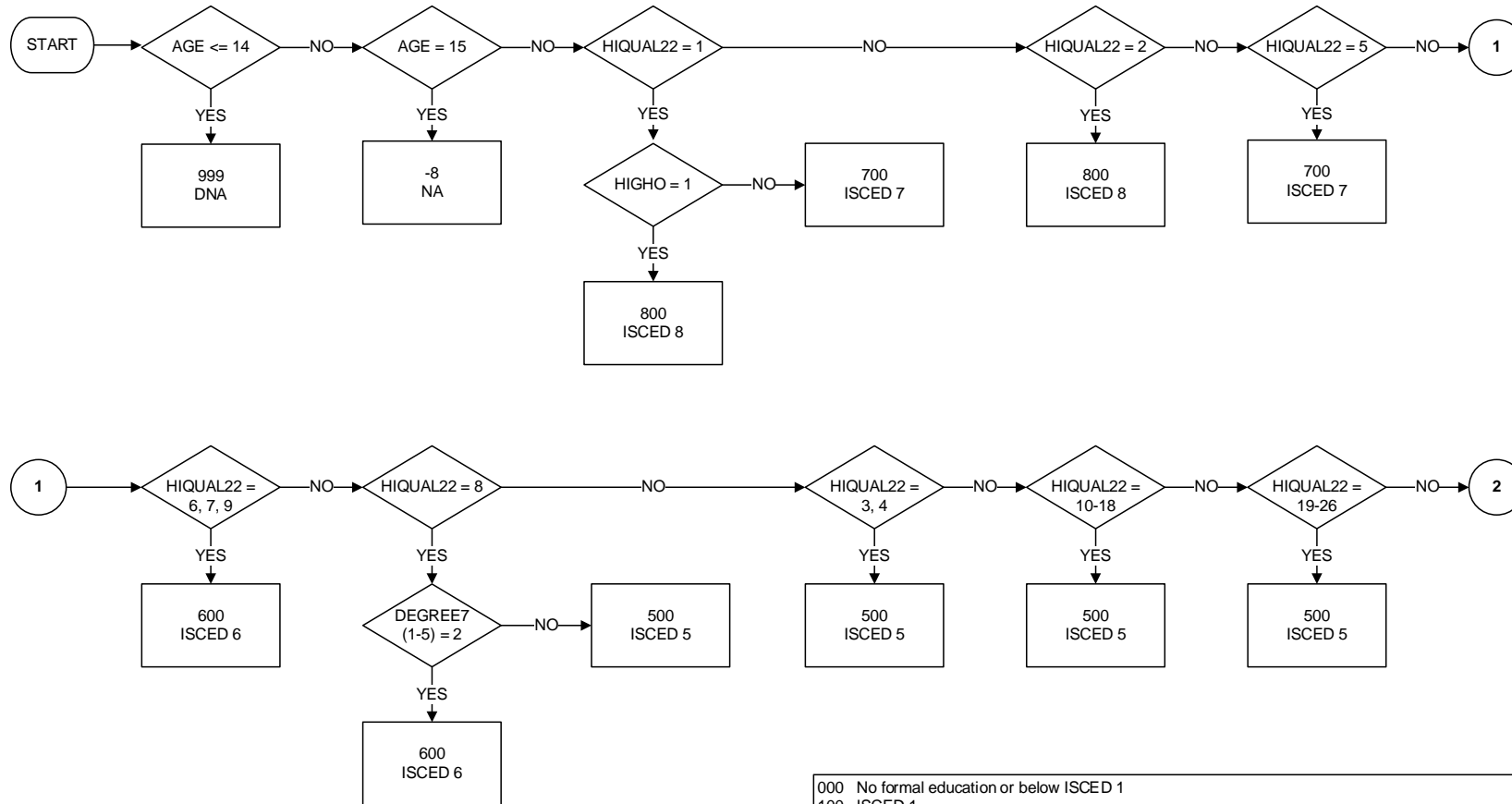

- 000 No formal education or below ISCED 1
- 100 ISCED 1
- 200 ISCED 2 (inc ISCED 3 programmes of duration less than 2 years)
- 302 ISCED 3 programme duration >= 2 years, sequential (i.e. access to next ISCED 3 programme only)
- 303 ISCED 3 programme duration >= 2 years, terminal or access to next ISCED 4 only (N/A in UK)
- 304 ISCED 3 with access to ISCED 5, 6 or 7
- 400 ISCED 4 (N/A in UK)
- 500 ISCED 5
- 600 ISCED 6
- 700 ISCED 7
- 800 ISCED 8
- 999 Not applicable (age < 15)

EHATLEV22 – Educational Attainment level (ISCED11)

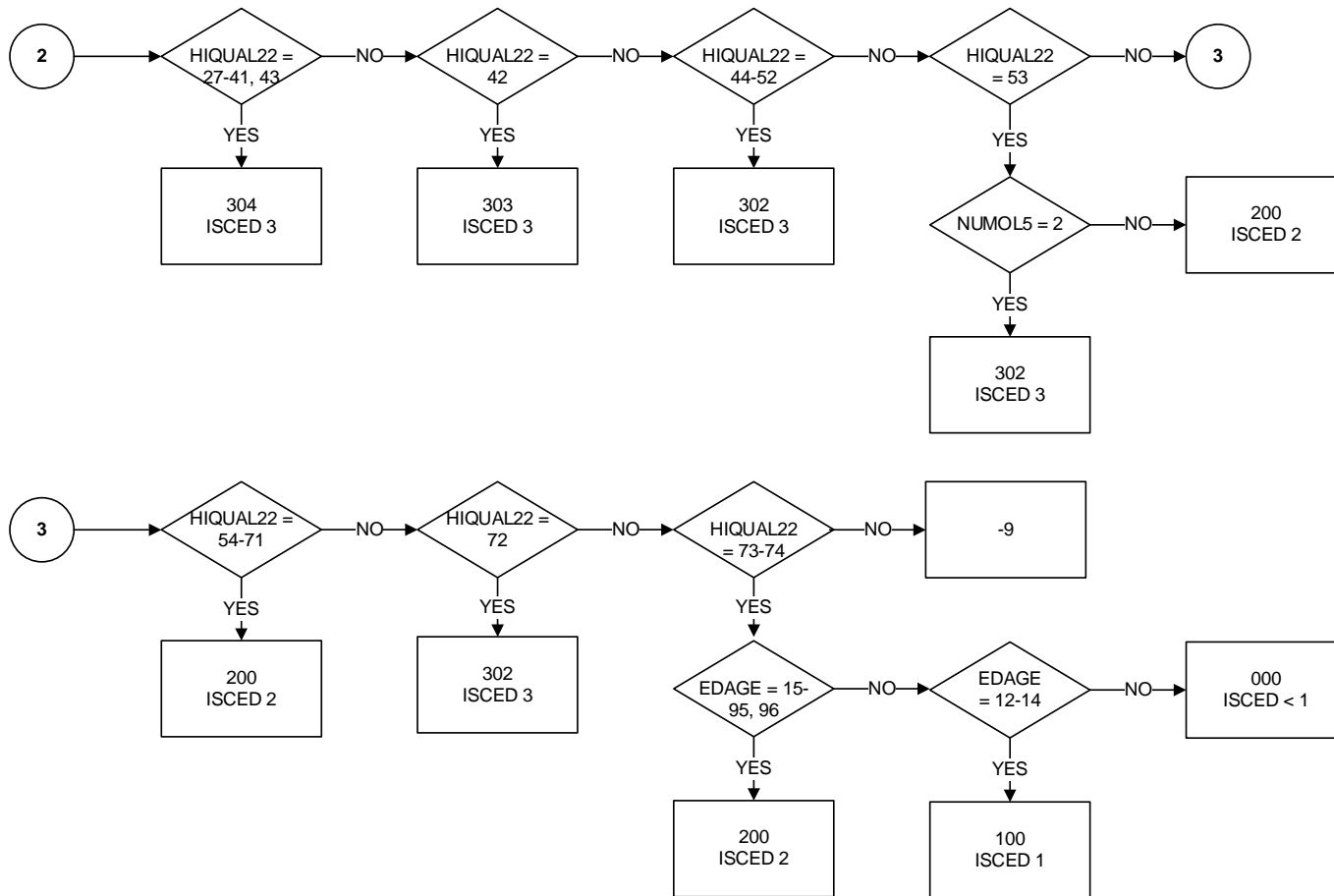

EHATYR22 Year when highest level of education or training successfully completed

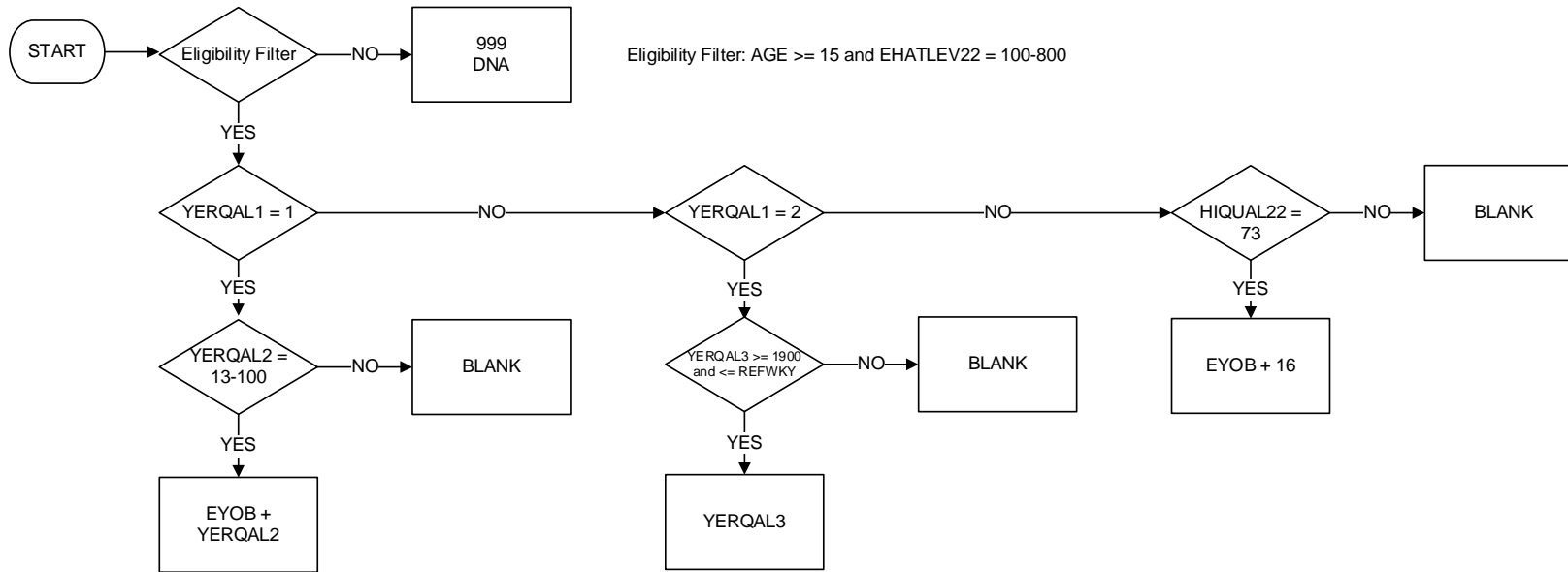

FLED22: Type of agreed working arrangements

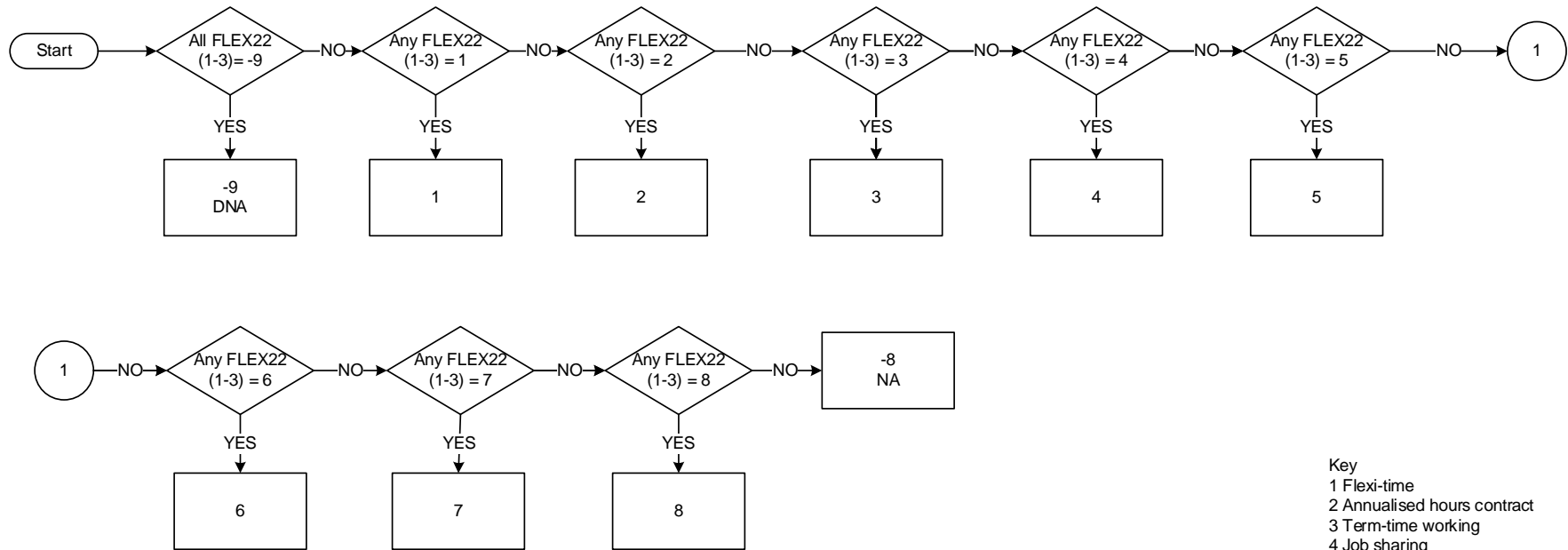

- Key
- 1 Flexi-time
 - 2 Annualised hours contract
 - 3 Term-time working
 - 4 Job sharing
 - 5 Condensed or compressed hours
 - 6 Zero hours contract
 - 7 On call working
 - 8 None of these

FLEX22W1: Whether respondent works flexi-time

Start date: Jan 2022

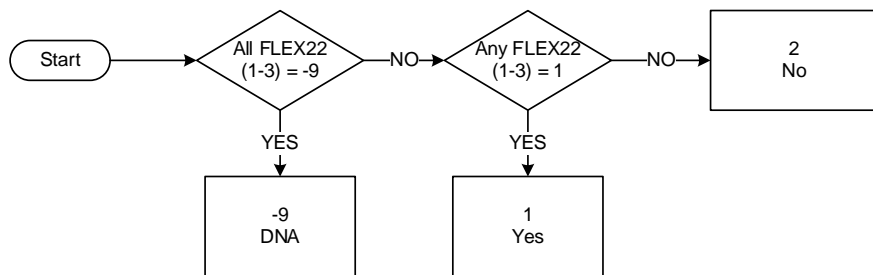

Key
1 - Respondent works flexi-time
2 - Respondent does not work flexi-time

FLEX22W2: Whether respondent works to annualised hours contract

Start date: Jan 2022

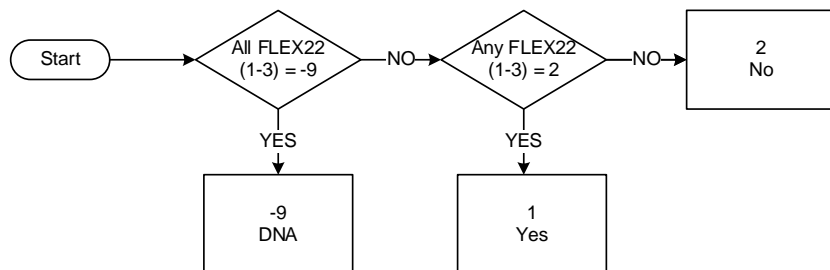

Key
1 - Respondent works to an annualised hours contract
2 - Respondent does not work to an annualised hours contract

FLEX22W3: Whether respondent works to a term time working arrangement

Start date: Jan 2022

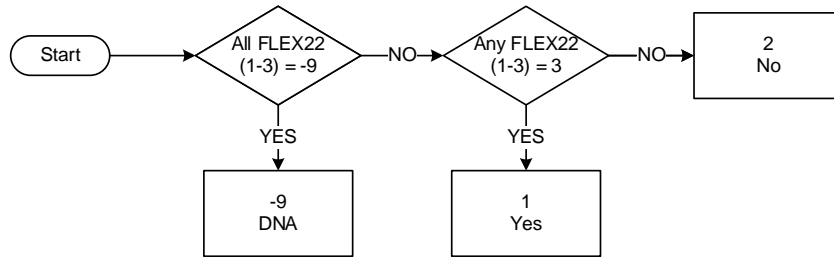

Key
1 - Respondent works to a term time working arrangement
2 - Respondent does not work a term time working arrangement

FLEX22W4: Whether respondent's work involves job sharing

Start date: Jan 2022

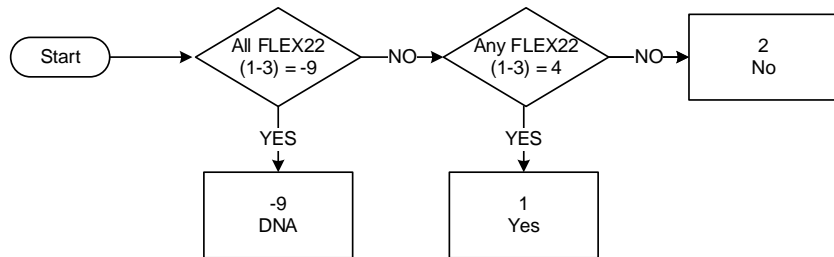

Key
1 - Respondent's work involves job sharing
2 - Respondent's work does not involve job sharing

FLEX22W5: Whether respondent works condensed/compressed hours

Start date: Jan 2022

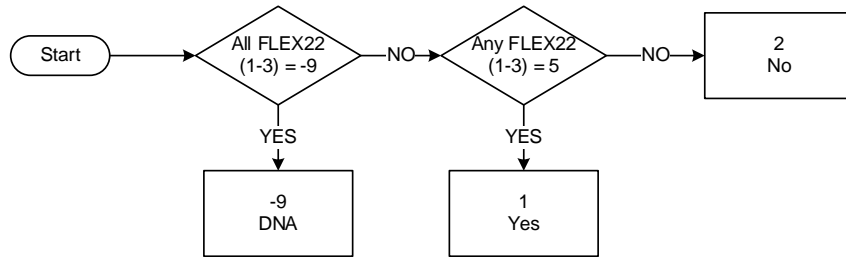

Key
1 - Respondent works condensed or compressed hours
2 - Respondent does not work condensed or compressed hours

FLEX22W6: Whether respondent works zero hours contract

Start date: Jan 2022

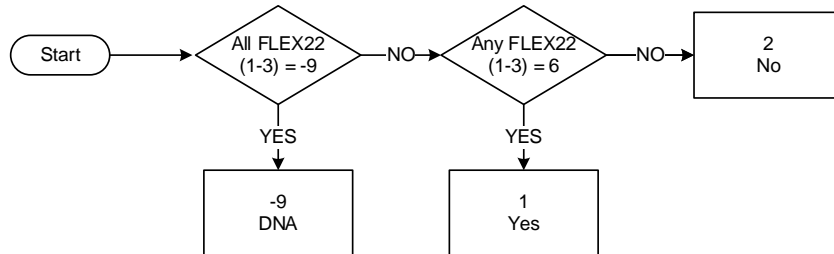

Key
1 - Respondent works a zero hours contract
2 - Respondent does not work a zero hours contract

FLEX22W7: Whether respondent works on call

Start date: Jan 2022

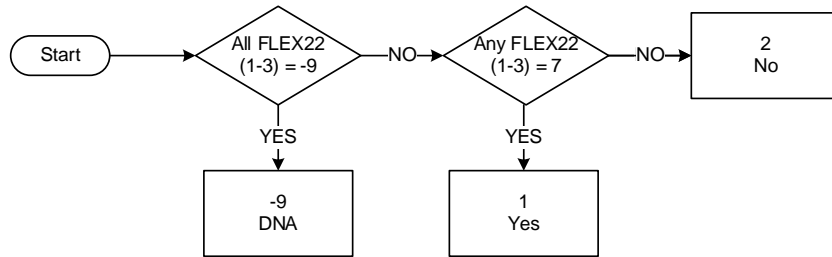

Key

1 - Respondent works on call

2 - Respondent does not work on call

FLEX22W8: Whether respondent works none of the working patterns described

Start date: Jan 2022

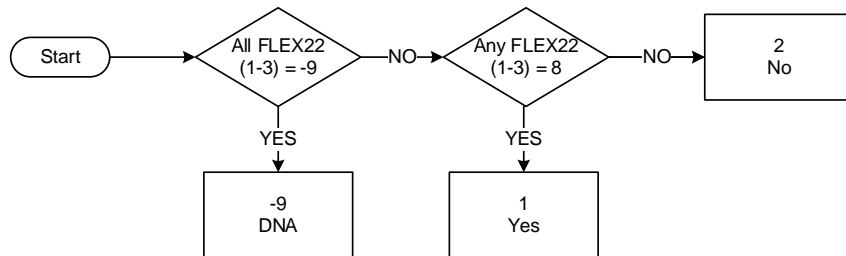

Key

1 - Respondent works none of the working patterns described

2 - Respondent works one or more of the working patterns described or replied DK

FLEX22W9: Whether respondent does not know which agreed working arrangements are worked

Start date: Jan 2022

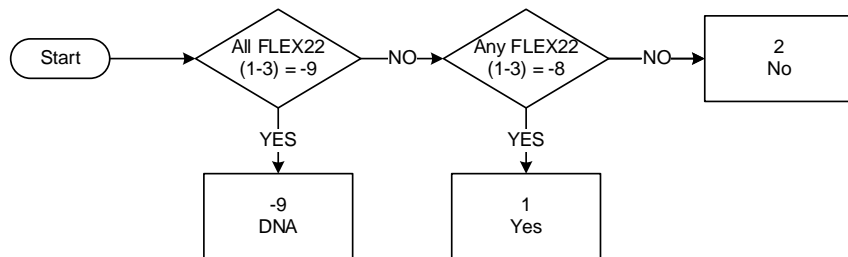

Key
1 - Respondent doesn't know which agreed working arrangements are worked
2 - Respondent replied other than 'don't know'

GCSEFUL1 – GCSE41 including inferred responses (2022 version)

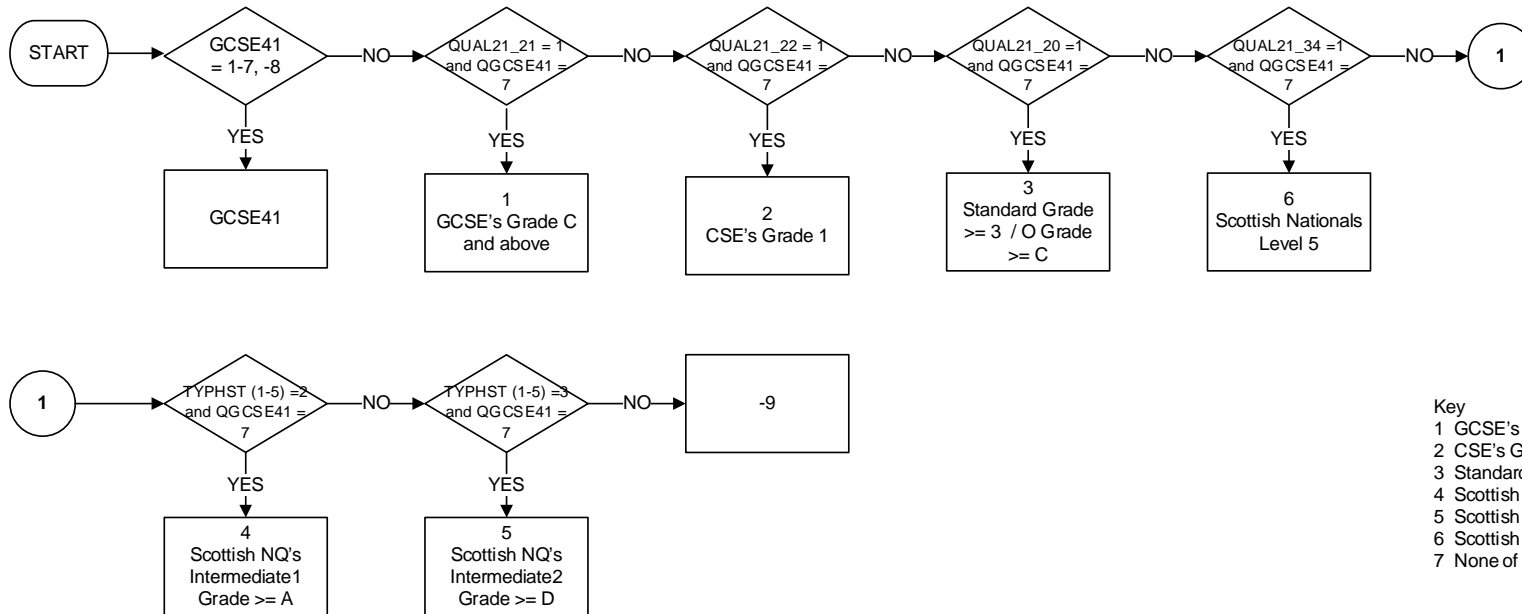

GCSEFUL2 – GCSE42 including inferred responses (2022 version)

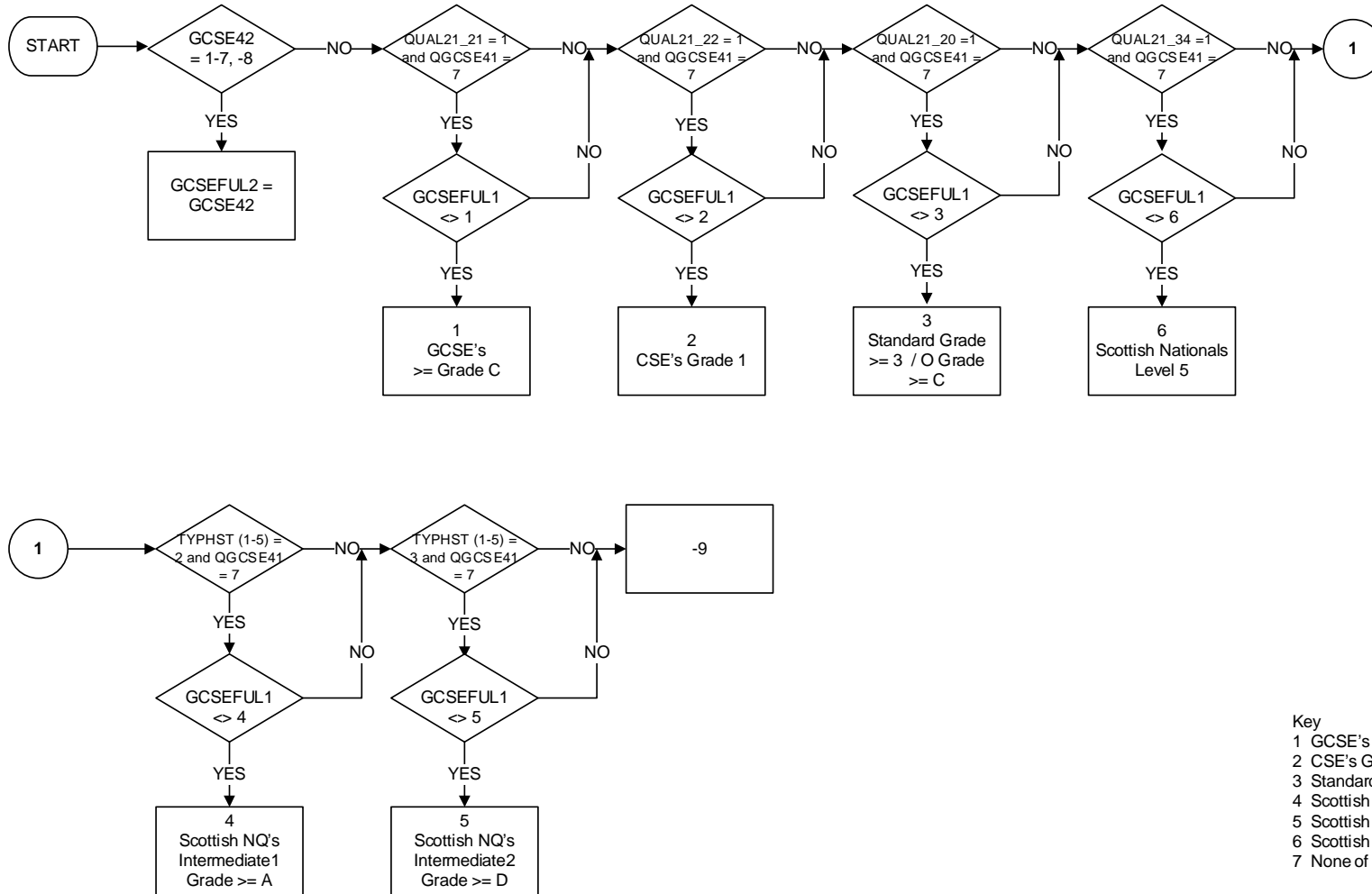

- Key
- 1 GCSE's Grade C and above
 - 2 CSE's Grade 1
 - 3 Standard Grade >= 3 / O Grade >= C
 - 4 Scottish NQ's Intermediate1 Grade >= A
 - 5 Scottish NQ's Intermediate2 Grade >= D
 - 6 Scottish Nationals Level 5
 - 7 None of these

GCSEFUL3 – GCSE43 including inferred responses (2022 version)

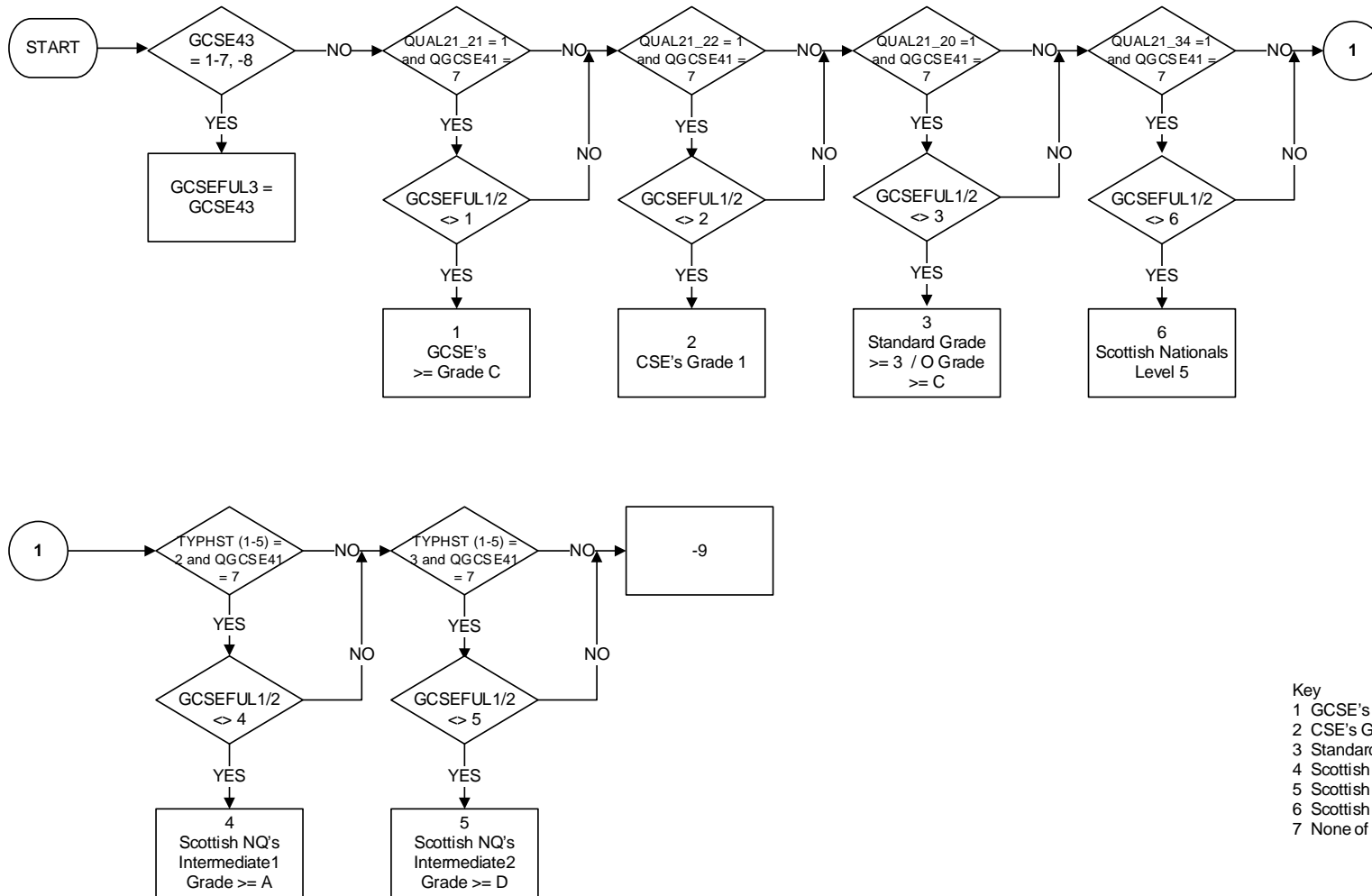

- Key
- 1 GCSE's Grade C and above
 - 2 CSE's Grade 1
 - 3 Standard Grade >= 3 / O Grade >= C
 - 4 Scottish NQ's Intermediate1 Grade >= A
 - 5 Scottish NQ's Intermediate2 Grade >= D
 - 6 Scottish Nationals Level 5
 - 7 None of these

GCSEFUL4 – GCSE44 including inferred responses (2022 version)

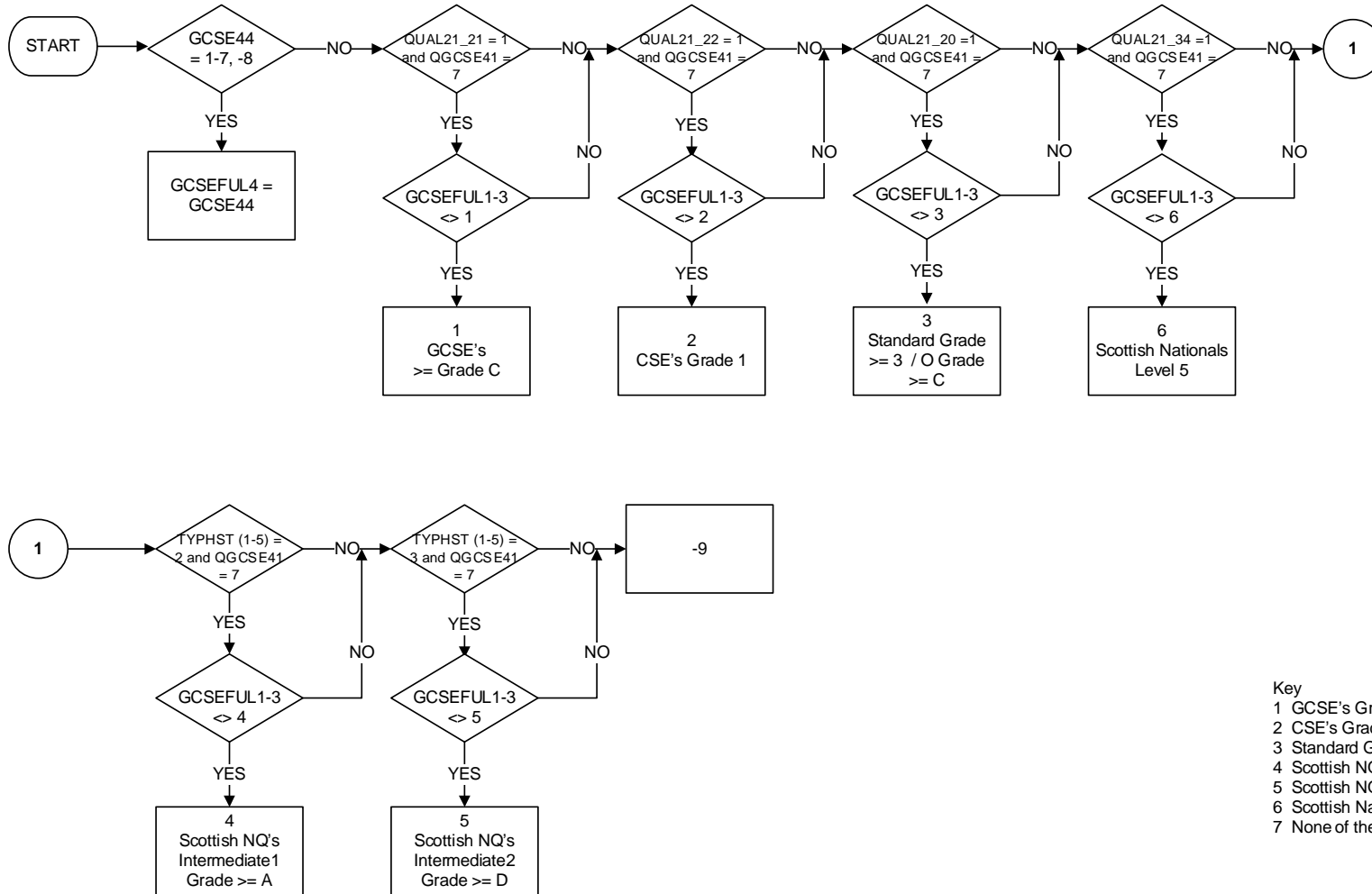

- Key
- 1 GCSE's Grade C and above
 - 2 CSE's Grade 1
 - 3 Standard Grade >= 3 / O Grade >= C
 - 4 Scottish NQ's Intermediate1 Grade >= A
 - 5 Scottish NQ's Intermediate2 Grade >= D
 - 6 Scottish Nationals Level 5
 - 7 None of these

GCSEFUL5 – GCSE45 including inferred responses (2022 version)

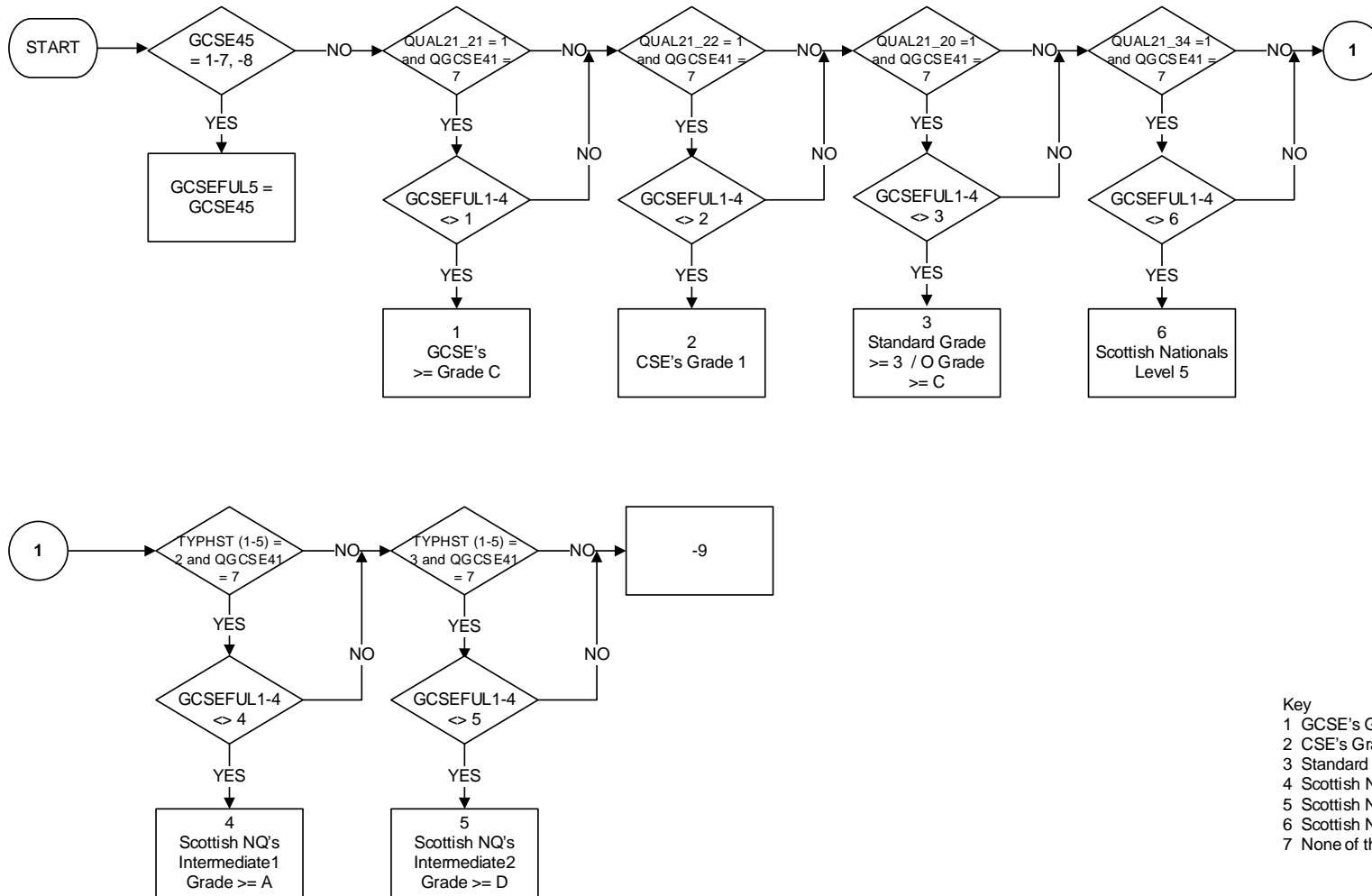

- Key
- 1 GCSE's Grade C and above
 - 2 CSE's Grade 1
 - 3 Standard Grade >= 3 / O Grade >= C
 - 4 Scottish NQ's Intermediate1 Grade >= A
 - 5 Scottish NQ's Intermediate2 Grade >= D
 - 6 Scottish Nationals Level 5
 - 7 None of these

GCSEFUL6 – GCSE46 including inferred responses (2022 version)

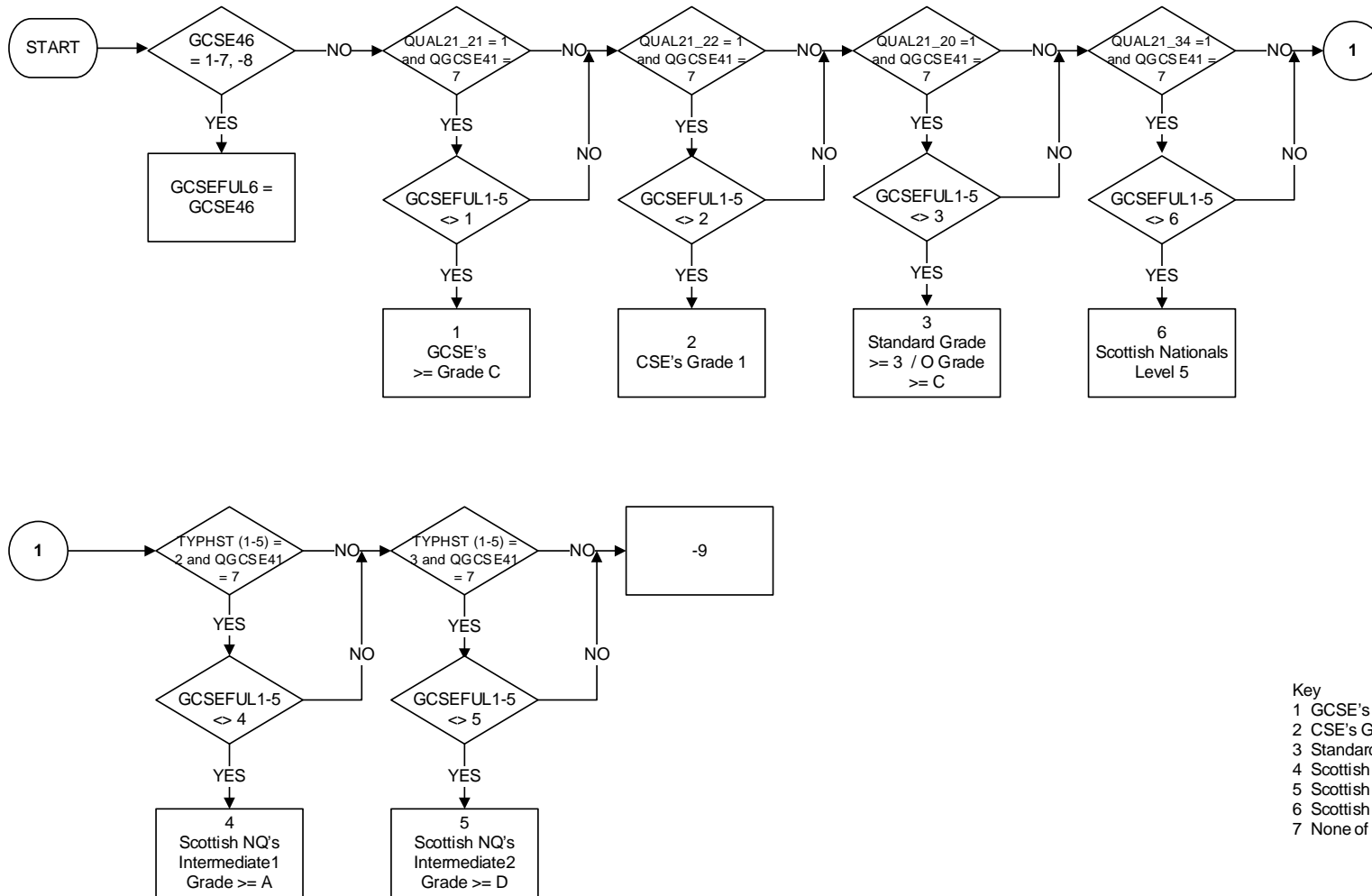

- Key
- 1 GCSE's Grade C and above
 - 2 CSE's Grade 1
 - 3 Standard Grade >= 3 / O Grade >= C
 - 4 Scottish NQ's Intermediate1 Grade >= A
 - 5 Scottish NQ's Intermediate2 Grade >= D
 - 6 Scottish Nationals Level 5
 - 7 None of these

HIQUAL22 - Highest qualification/ Trade apprenticeship

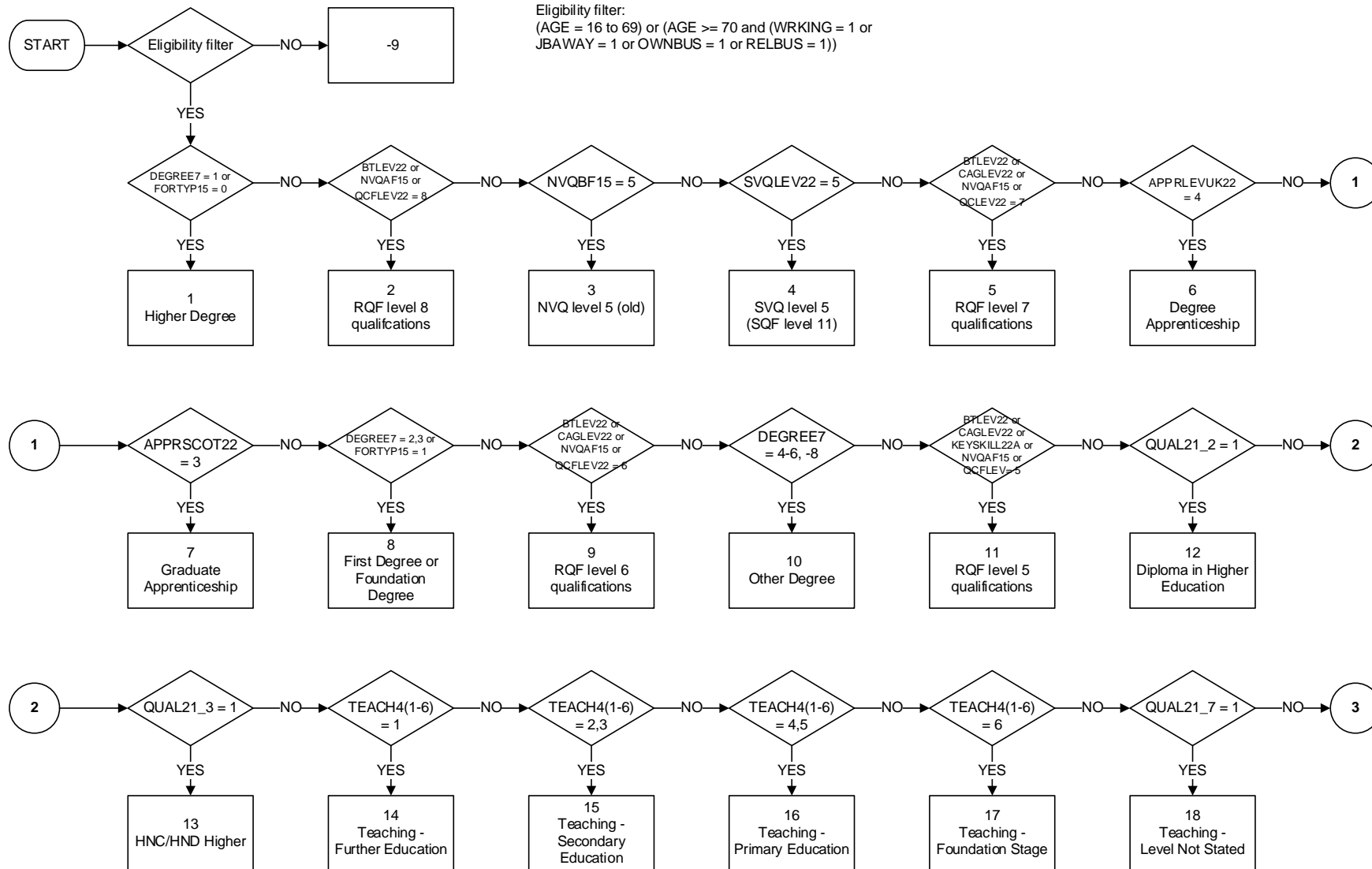

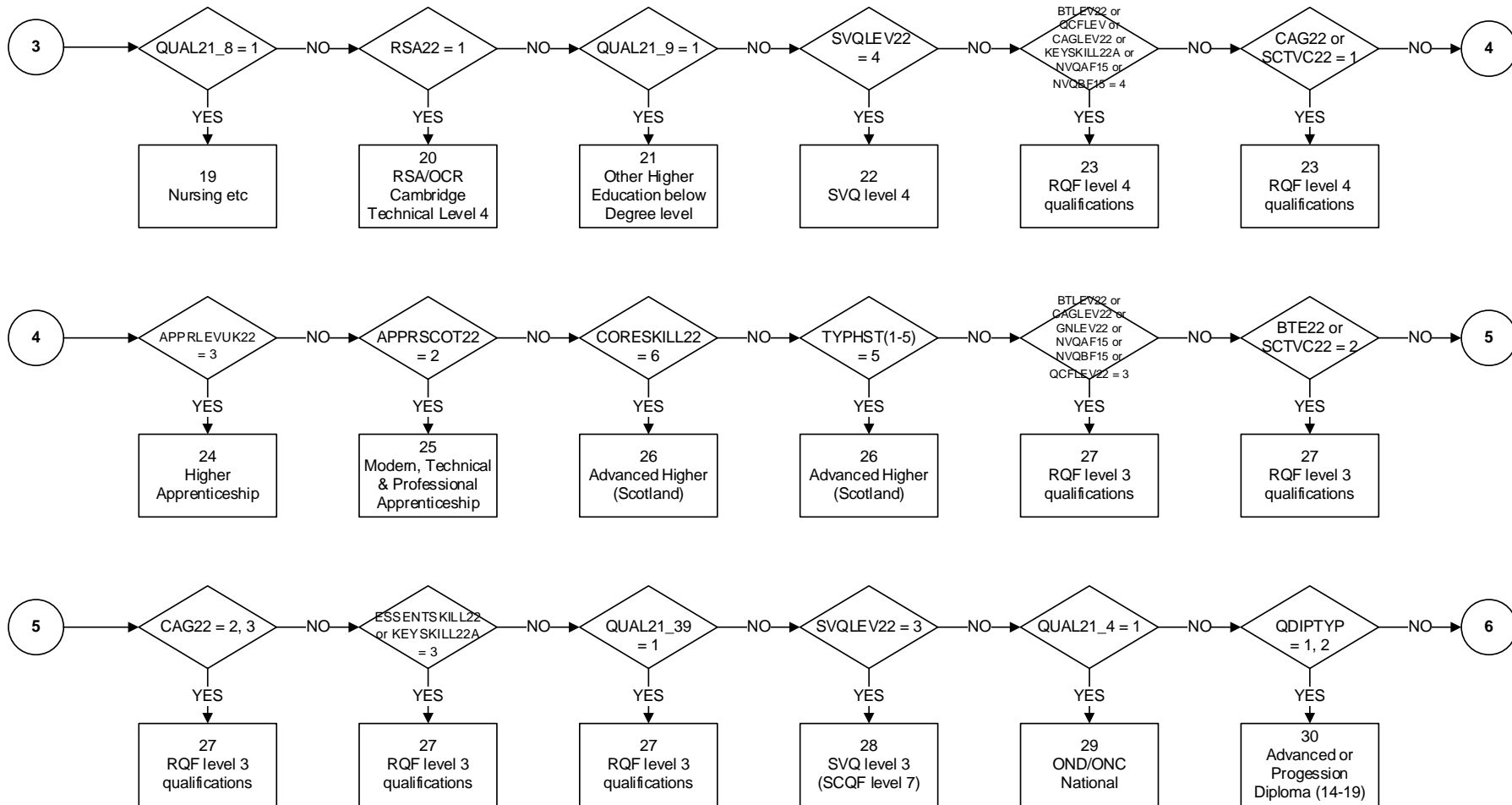

HIQUAL22 - Highest qualification/ Trade apprenticeship

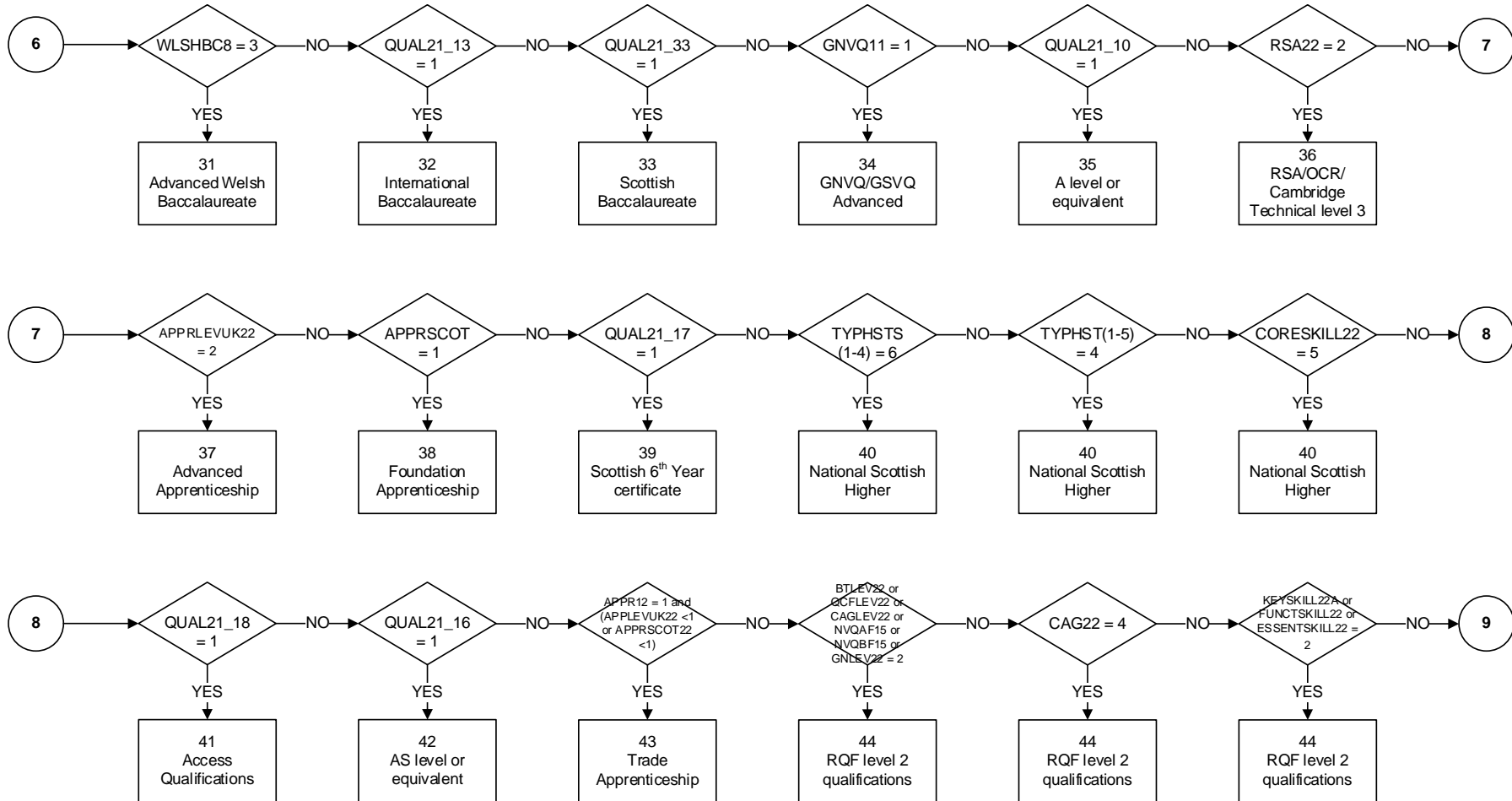

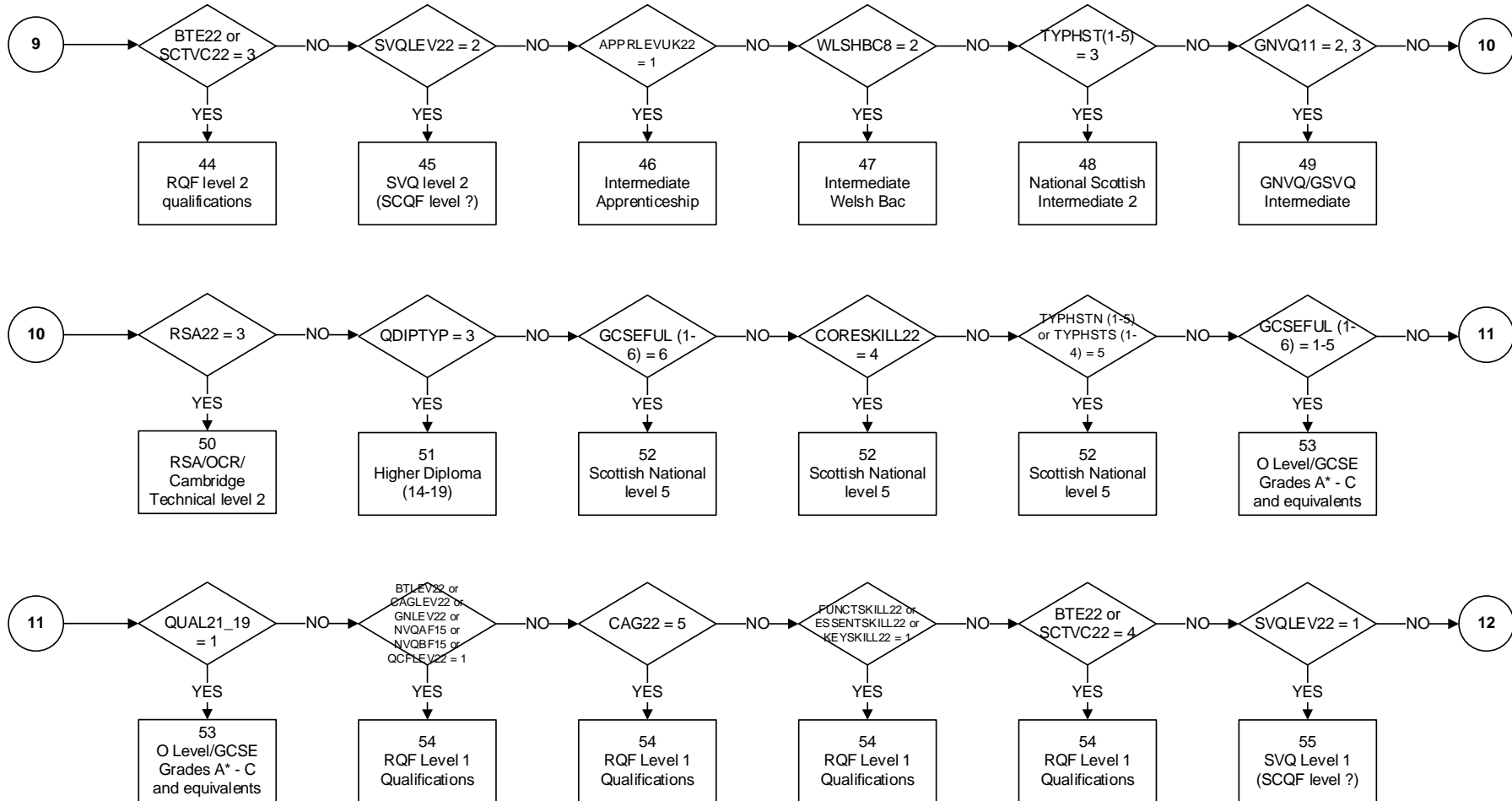

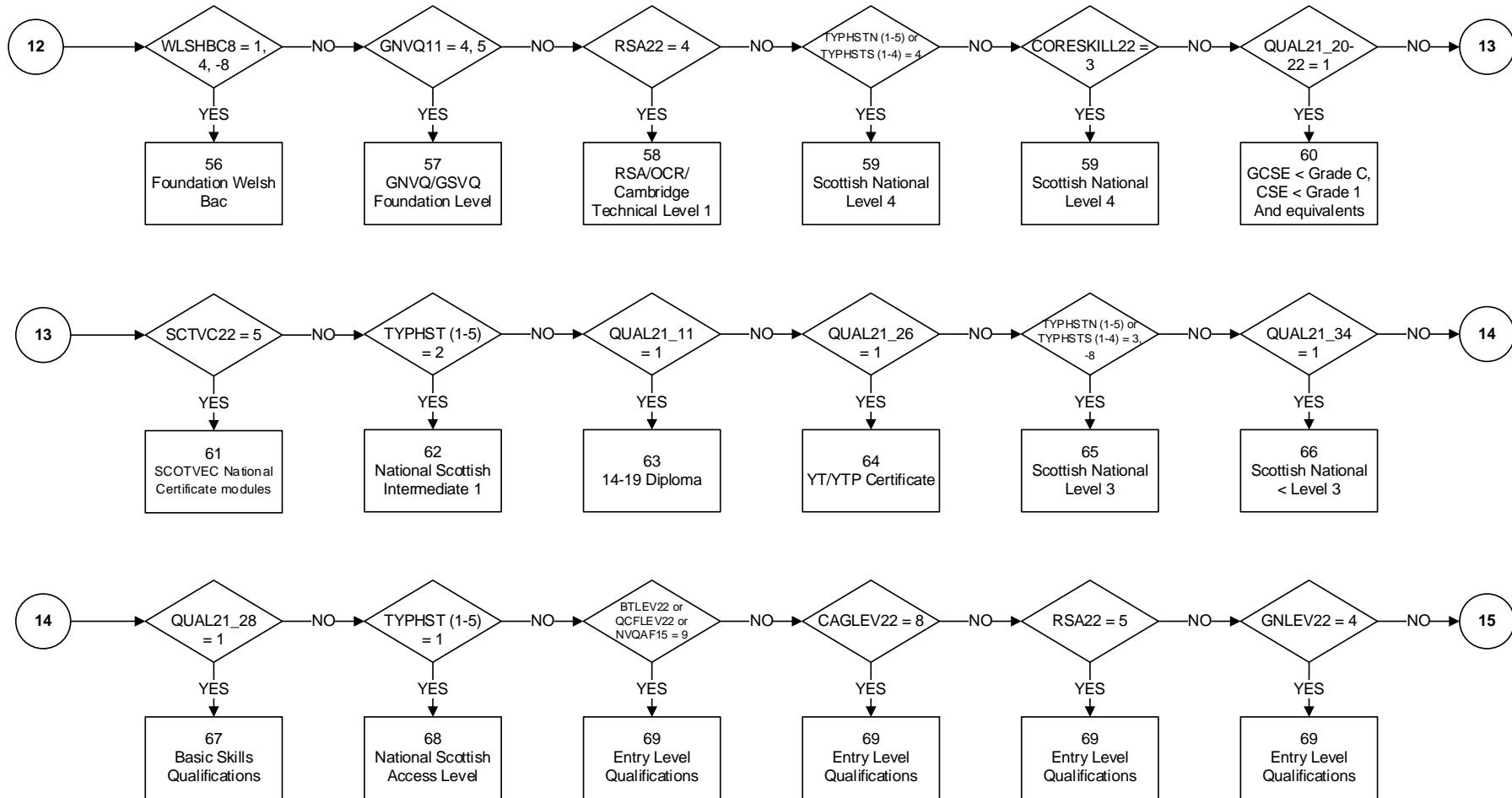

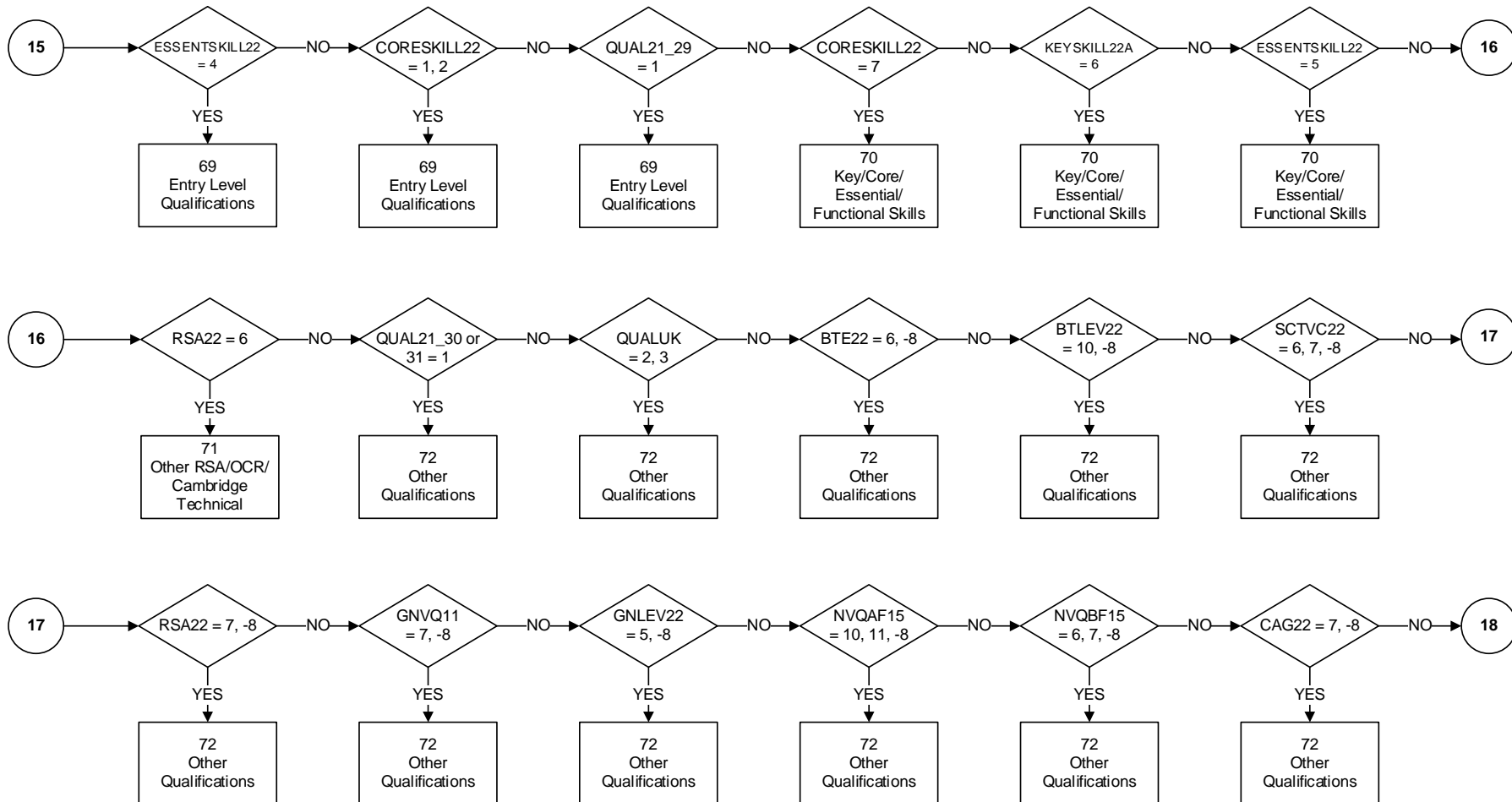

HIQUAL22 - Highest qualification/ Trade apprenticeship

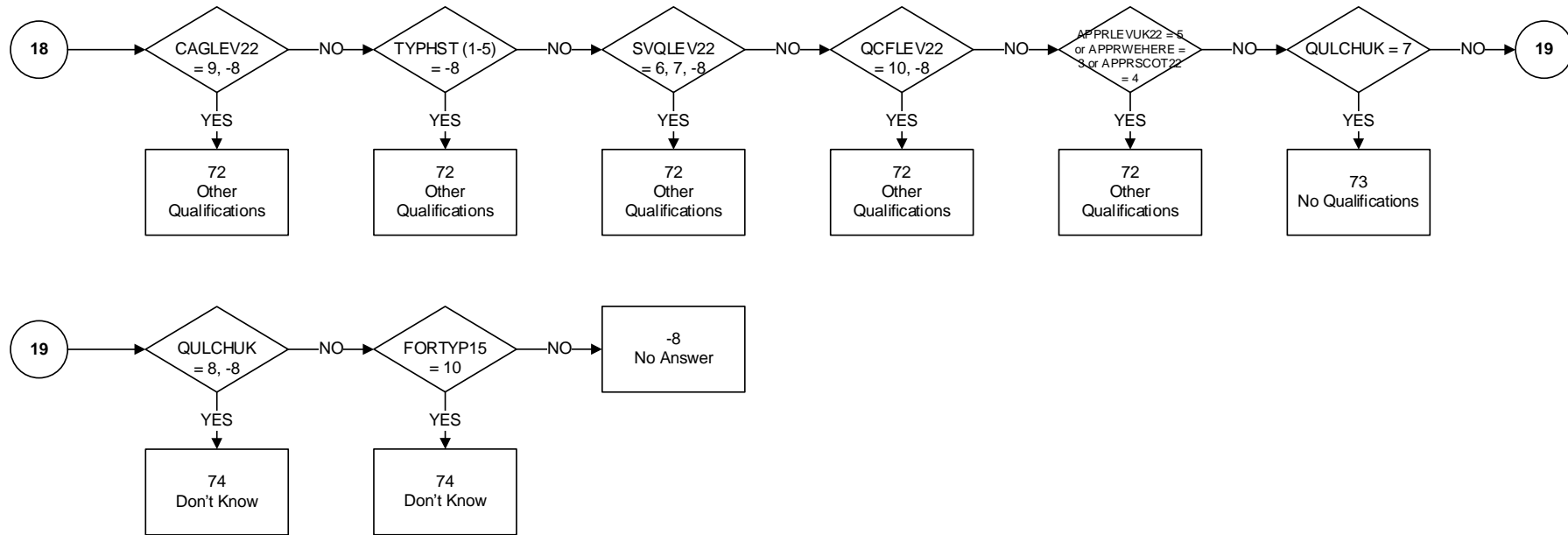

HIQUL22D - Highest qualification/ Trade apprenticeship (detailed grouping)

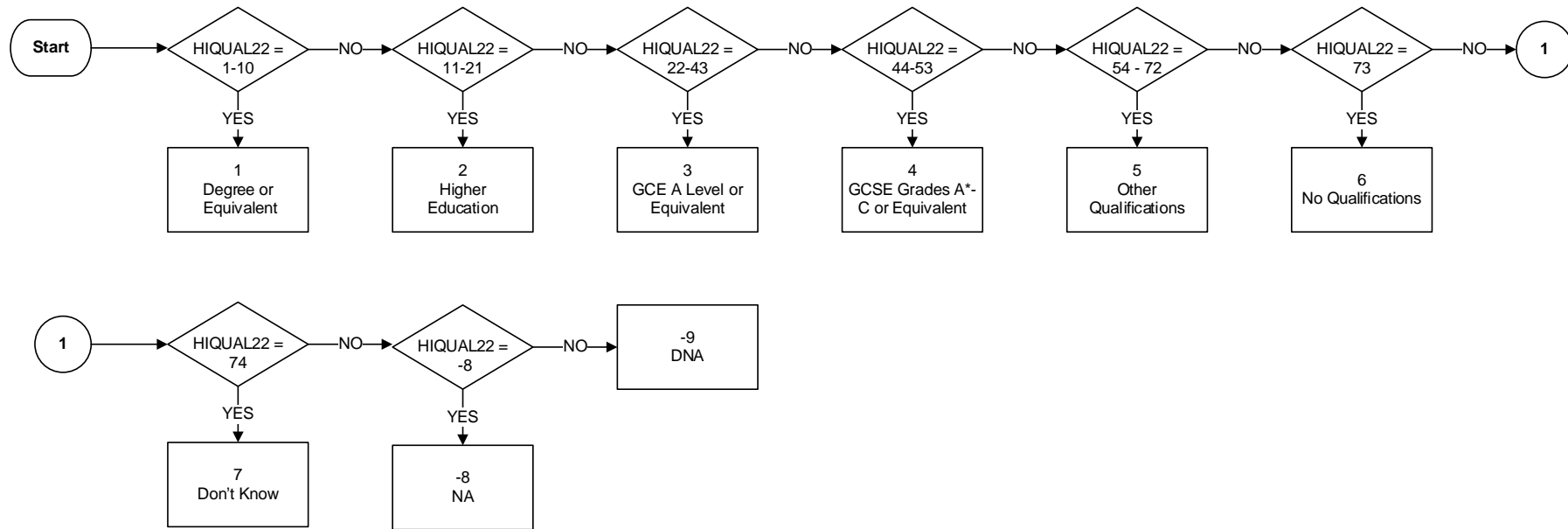

LEVQUL22 – RQF Level of highest qualification held

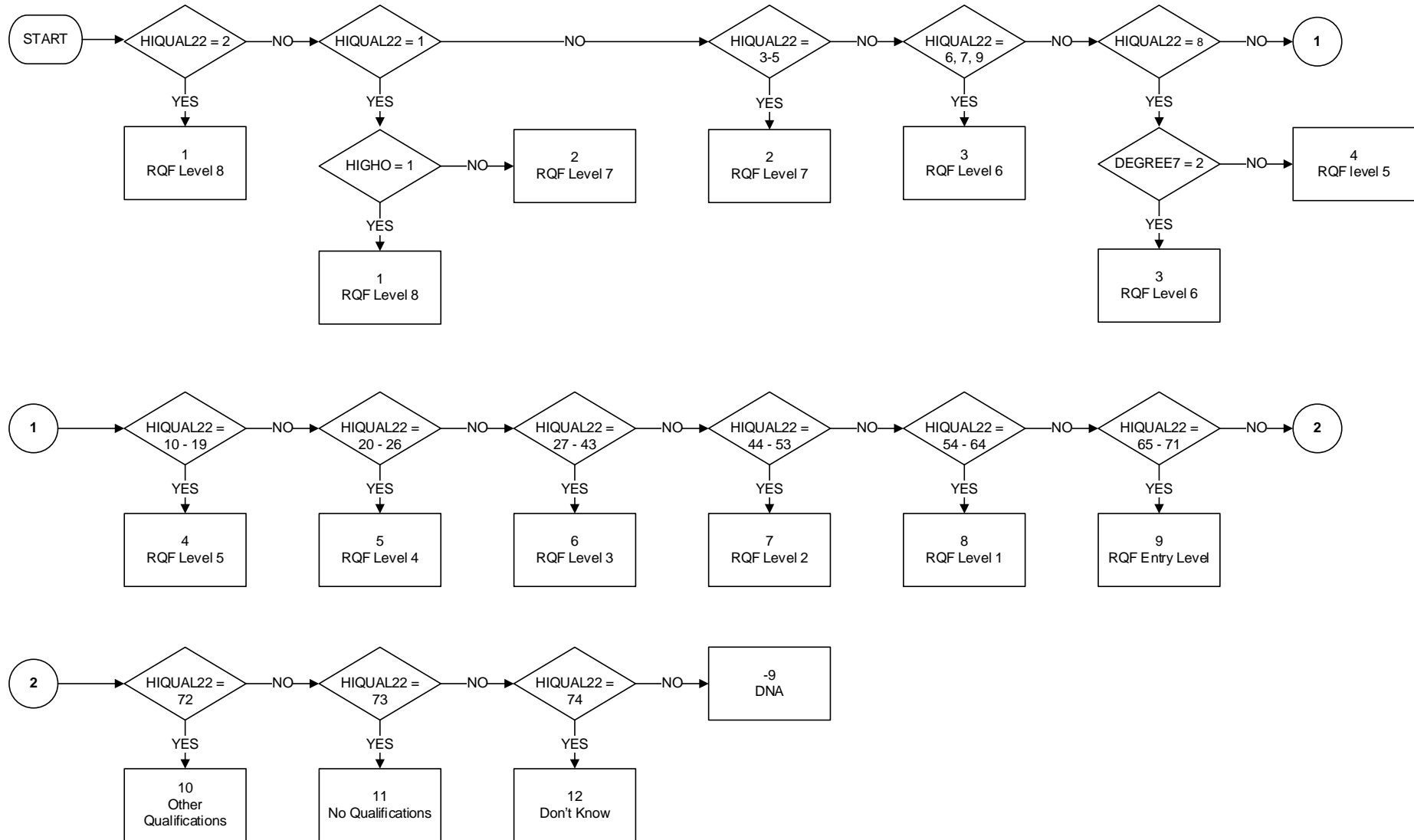

QUAL21_1 to QUAL21_39 – Individual Qualifications Gained

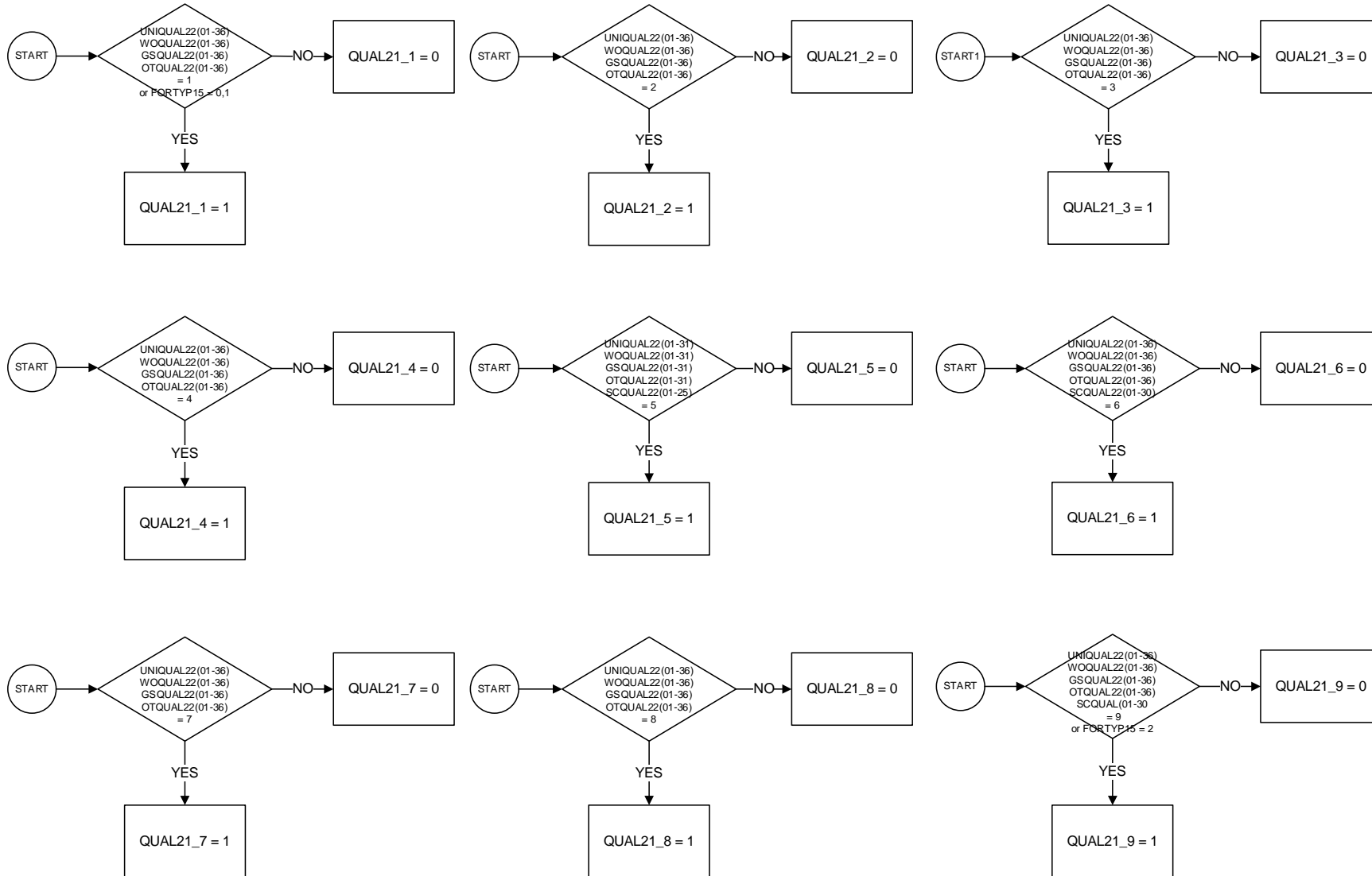

QUAL21_1 to QUAL21_39 – Individual Qualifications Gained

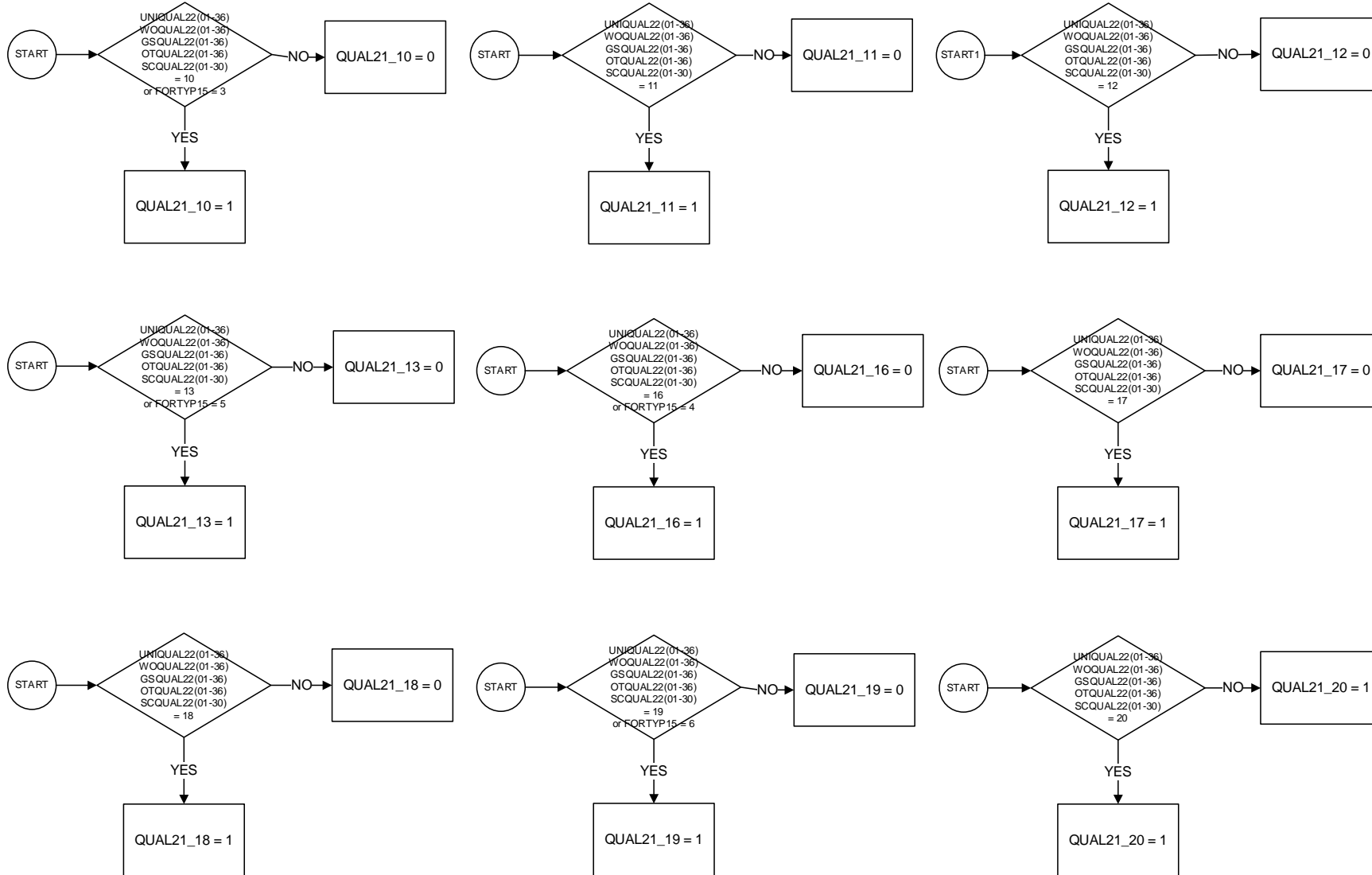

QUAL21_1 to QUAL21_39 – Individual Qualifications Gained

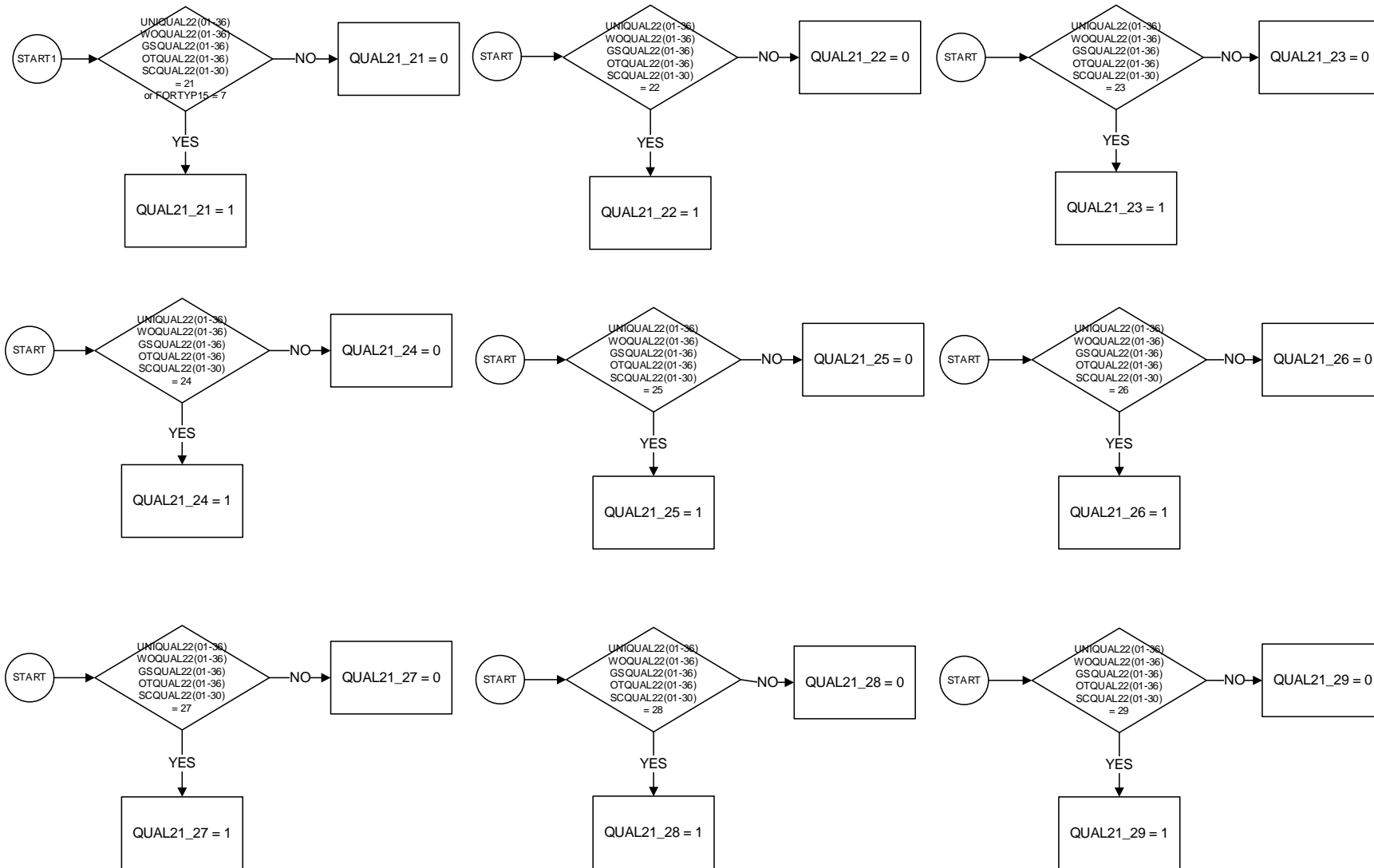

QUAL21_1 to QUAL21_39 – Individual Qualifications Gained

Start date: Jan 2022

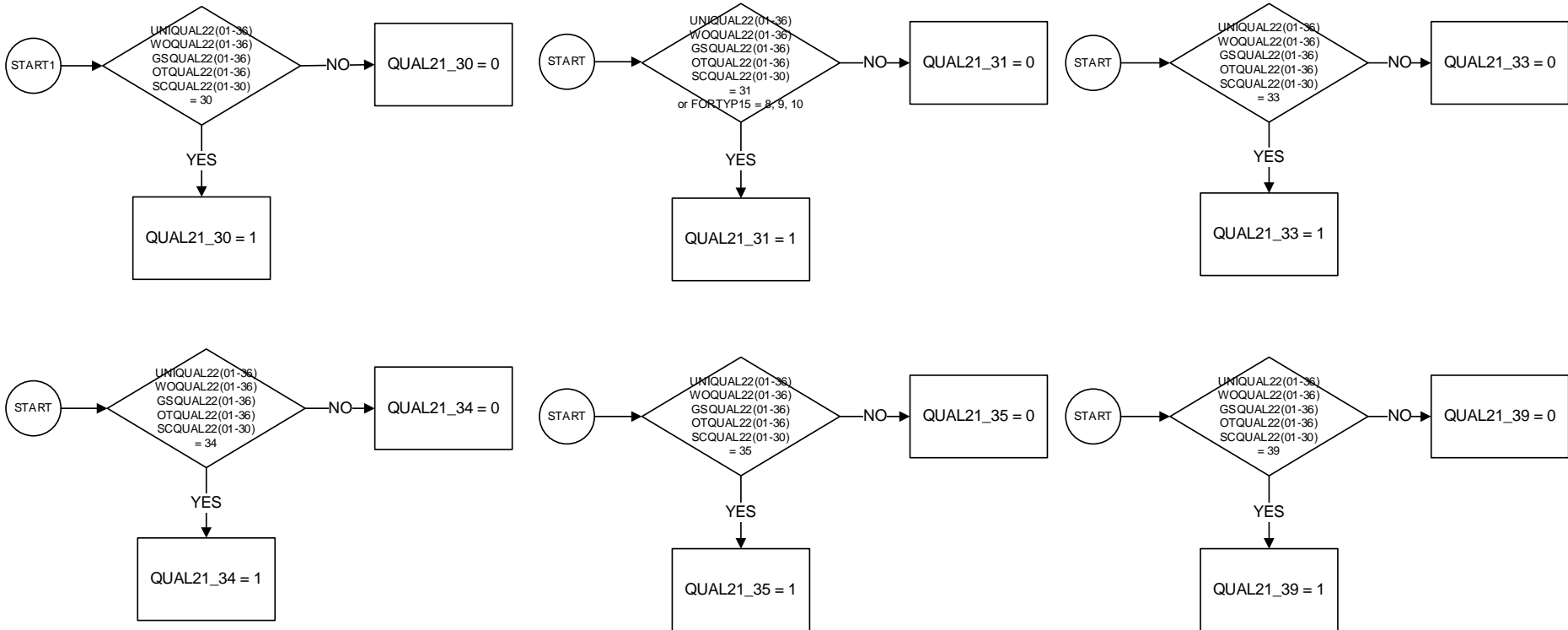

QUAL21_1 to QUAL21_39 – Individual Qualifications Gained

Start date: Jan 2022

QUAL21_1 to QUAL21_39 codes every qualification gained from school, university, work, government schemes and other and foreign qualifications, giving a list of all qualifications gained, regardless of where from. For example, if a respondent has: QUAL21_1 = 1 and QUAL21_7 = 1 and QUAL21_29 = 1 this indicates that they have: a degree level qualification, a teaching qualification and an Entry Level qualification.

Key

QUAL21_1 – Degree level qualification including foundation degree, graduate membership of a professional institute, PGCE, or higher qualifications
 QUAL21_2 – Diploma in Higher Education
 QUAL21_3 – HNC/HND
 QUAL21_4 – ONC/OND
 QUAL21_5 – BECTEC/BEC/TEC/Edexcel/LQL
 QUAL21_6 – SCOTVEC/SCOTEC/SCOTBEC
 QUAL21_7 – Teaching qualification (exc PGCE)
 QUAL21_8 – Nursing or other medical qualification not yet mentioned
 QUAL21_9 – Other Higher Education qualification below degree level
 QUAL21_10 – A Level/Vocational A Level/GCE in applied subjects or equivalents
 QUAL21_11 – New Diploma
 QUAL21_12 – Welsh Baccalaureate
 QUAL21_13 – New Baccalaureate
 QUAL21_14 – N/A (NVQ/SVQ to Dec 2021)
 QUAL21_15 – N/A (GNVQ/GSVQ to Dec 2021)
 QUAL21_16 – AS Level/Vocational AS Level or equivalent
 QUAL21_17 – Certificate of 6th Year Studies (CSYS) or equivalent
 QUAL21_18 – Access to Higher Education
 QUAL21_19 – O Level or equivalent
 QUAL21_20 – Standard/Ordinary (O) grade/Lower (Scotland)
 QUAL21_21 – GCSE/Vocational GCSE
 QUAL21_22 – CSE
 QUAL21_23 – Advanced Higher/Higher/Intermediate/Access qualifications (Scotland)
 QUAL21_24 – RSA/OCR
 QUAL21_25 – City & Guilds
 QUAL21_26 – Youth Training (YT) Certificate
 QUAL21_27 – Key Skills/Core Skills (Scotland)
 QUAL21_28 – Basic Skills (Skills for Life/Literacy/Numeracy/Language)
 QUAL21_29 – Entry Level qualifications
 QUAL21_30 – Award/Certificate/Diploma at Entry Level or Levels 1-8
 QUAL21_31 – Any other professional/work related qualification
 QUAL21_32 – N/A
 QUAL21_33 – Scottish Baccalaureate
 QUAL21_34 – Scottish Nationals
 QUAL21_35 – Skills for Work (Scotland)
 QUAL21_36 – N/A
 QUAL21_37 – N/A
 QUAL21_38 – N/A
 QUAL21_39 – Core Maths

A Note on the lower counts for the new or revised education variables in JM22

IOUTCOME = 6 identifies cases for which there is a) no response in the current quarter, and b) a response in the previous quarter. In such circumstances the previous quarter's data is 'brought forward' – such cases are also described as 'data brought forward' (DBF).

However, when the underlying questionnaire variables change, as happened with a number of the education questions from OD21 into JM22, the practice of bringing forward the values from the previous quarter is not possible. As such, the new/revised education derived variables (eg HIQUAL22 and LEVQUL22) through JM22 will not include values for any IOUTCOME = 6 (DBF) cases, which typically constitute up to 25% of the total. The counts for the responding IOUTCOME categories – 1 Personal Responders and 2 Proxy Responses – are broadly consistent with previous quarters.